

STONE STRONG SYSTEMS

# Field Construction Manual

Version 1.1 / March 2009



Field construction manual for Stone Strong Systems precast modular unit retaining wall system.

S t o n e   S t r o n g ,   L L C

TOC

INTRODUCTION .....1

CONSTRUCTION RESPONSIBILITIES .....1  
     Stone Strong Dealer  
     Engineer or owner’s Representative  
     Contractor

MATERIAL, DELIVERY, STORAGE AND HANDLING .....2

EQUIPMENT AND SUPPLIES .....3  
     Contractor Supplied Materials and tools

SITE PREPARATION .....3

EXCAVATION .....4

FOUNDATION PREPARATION .....4

WALL BASE CONSTRUCTION .....4

GRAVITY WALL UNIT INSTALLATION .....5  
     First Course  
     Subsequent Courses

BACKFILL PLACEMENT AND COMPACTION .....10

CLEANUP .....11

TROUBLESHOOTING .....11

TOP OF WALL TREATMENTS .....13

MINIMUM RADIUS TABLES .....15

GLOSSARY .....16



## INTRODUCTION

This installation manual is designed to provide general information and assist in the proper techniques required to build STONE STRONG walls. The manual covers the basics of wall construction, and contains many of the details encountered in site work. Look to our web site *Stonestrong.com* or our Stone Strong Engineering Manual or the local wall design engineer for information not included here. Building structurally sound walls requires a high level of care and expertise. Begin with a thorough review of the site.

## CONSTRUCTION RESPONSIBILITIES

### Stone Strong Dealer

Stone Strong representatives may assist the owner, contractor and inspectors in scheduling of materials, construction procedures, contract documents, plans and specifications. The representative is available to assist and train the contractor and inspectors as requested and necessary.

### Engineer or Owner's Representative

Owner representative or Engineer is responsible for the enforcement of the contract documents, plans and specifications. Owner shall employ services of a material engineering firm to provide quality control testing during embankment construction.

Owner and Engineer shall not be responsible for means or methods of construction or for safety of workers or of the public.

### Contractor

The contractor will be responsible for checking the materials upon delivery to assure that proper materials have been received.

Protecting the materials from damage. Damaged material shall not be incorporated into the wall or the reinforced soil embankments.

Preventing excessive mud, concrete, adhesives and other substances that may adhere from coming in contact with the materials.

Furnishing and installing Stone Strong unit to the lines and grades shown on the plans and as specified herein.

The contractor is solely responsible for safety.



## MATERIALS, DELIVERY STORAGE AND HANDLING

Precast modular unit shall be Stone Strong unit manufactured under license from Stone Strong, LLC.

Stone Strong System units:

24 SF wall unit	6 SF wall unit
24 SF top unit	6 SF top unit
End/corner unit	End/corner top unit
45 degree unit	90 degree unit
3 SF unit	3 SF top unit
24 SF mass extender unit	24 SF reinforced unit
Dual face unit	Cap/step unit

Dimension tolerances for precast modular unit shall be +/- 1/8 inch for horizontal and vertical dimensions of the face and +/- 1/2inch to -1/4 inch for the face to tail width.

Concrete for precast modular unit shall have a minimum 28-day compressive strength of 4,000 psi. Entrained air content shall be between 5 and 7%.

Reinforcing steel (if used) shall be Grade 60. Minimum clear cover to reinforcement shall be 1½ inches.

Check the materials upon deliver to assure that proper material has been received. Remove damaged or otherwise unsuitable material, from the site.

Exposed faces of Stone Strong unit shall be free of chips, cracks, bug holes, stains, and other imperfections distracting from their appearance when viewed from a distance of 10 feet.

Prevent mud concrete, adhesives and other substances that may harm appearance of unit from coming in contact with the system components.

Geotextile filter, pre-fabricated drainage composite shall be delivered, stored, and handled in accordance with ASTM D 4873.



## EQUIPMENT AND SUPPLIES

### Contractor Supplied Materials and Tools

The following tools are recommended, but should not be limited to this list. Site conditions may require other equipment, tools and materials.

Tools and Equipment:

Excavator	Laser Level
Skid Steer	10 foot Level
Front Loader	Shovels
Compactor	Brooms
Spreader Bar (48")	Pry Bars
Chains	Labor

Materials:

Wall Base Material	Off Site Borrow (if required)
Unit Fill Material	Filter Fabric (if required)
Drain Tile (if required)	Hand Rail (if required)

## SITE PREPARATION

Review the approved site plan to confirm lot lines, wall location, length and elevations.

Schedule preconstruction meeting.

Verify the on-site soil conditions.

Call the local utility companies to confirm the location of underground utilities.

Obtain all necessary building permits.

Confirm drainage to avoid erosion or buildup of water behind the wall.



## EXCAVATION

Lay out the location and length of the wall. If possible always start the wall base as the lowest elevation of the wall. Set wall elevations using a laser level and stakes prior to excavating; due to the size of the Stone Strong unit this method will increase efficiency.

Excavate as required for installation of the retaining wall system. Use caution not to over-excavate beyond depth needed for the foundation.

Slope or shore excavation as necessary for safety and for conformance with applicable OSHA requirements.

## FOUNDATION PREPARATION

Foundation soils shall be excavated as required for wall base to the dimensions shown on the plans. Foundation soil shall be observed by the Geotechnical Engineer to confirm that the bearing soils are similar to the design conditions or assumptions.

Foundation soil shall be proof rolled and compacted a minimum of 95 percent of the maximum dry density (ASTM D 698, Standard Proctor) and inspected by the Owner's Engineer prior to placement of leveling pad materials. The contractor shall replace any unsuitable soils discovered during excavation at the direction of the engineer.



## WALL BASE CONSTRUCTION

Construct the wall base to the lines and grades shown on the plans. The base may be constructed from concrete or granular material. Construct base to the material and dimensions shown on the plans. Over excavated areas shall be filled with additional concrete or granular base material. Wall base shall consist of a lean concrete with a minimum 28-day compressive strength of 3,000 psi, or a dense graded crushed aggregate. A minimum of 75% of coarse material shall have 2 or more fractured faces. Wall base material shall meet the following gradation:

US Standard Sieve Size	Percent Passing
1-1/2"	80-100
3/4"	50-90
#4	0-40
#200	0-10



## WALL BASE CONSTRUCTION *cont.*

Compact the wall base to provide a hard and level surface to support the Stone Strong unit. Base material shall be compacted to a minimum of 95 percent of the maximum dry density (ASTM D 698, Standard Proctor).

Prepare and smooth the granular material to ensure complete contact of the first course with the wall base. The surface of granular base may be dressed with finer aggregate to aid leveling, provided that the thickness of dressing layer should not exceed 3 times the maximum particle size used.



Concrete may be placed full thickness or as a topping to level the base. If used as a topping, the concrete shall have a minimum thickness of 3 inches.

It is important to ensure that the wall base has proper drainage. Consult with the engineer if added drainage is needed.

## WALL UNIT INSTALLATION

### First Course

Place the first course of Stone Strong unit directly on the wall base (see detail 1). If possible, begin placing Stone Strong unit at the lowest section of the wall. The unit shall be leveled side-to-side, front-to-rear and with adjacent unit. Ensure those Stone Strong units are in full contact with the compacted base. Adjacent unit should be in contact. The first course is the most important to ensure accurate and acceptable results. Leveling should be done by means of a 10 foot level across the top of the unit.

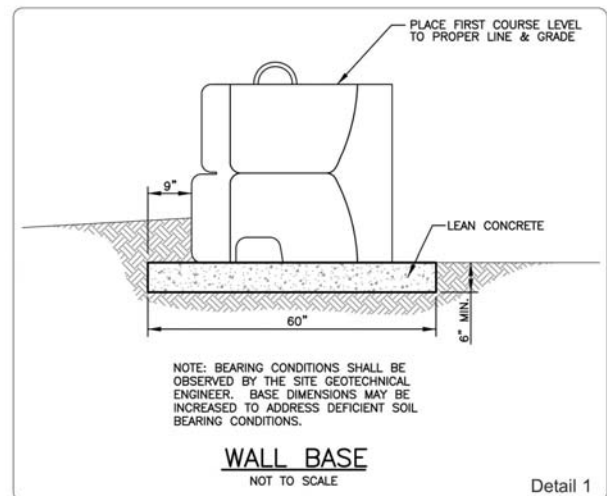

If the wall base elevation varies refer to detail 2 for wall base steps.

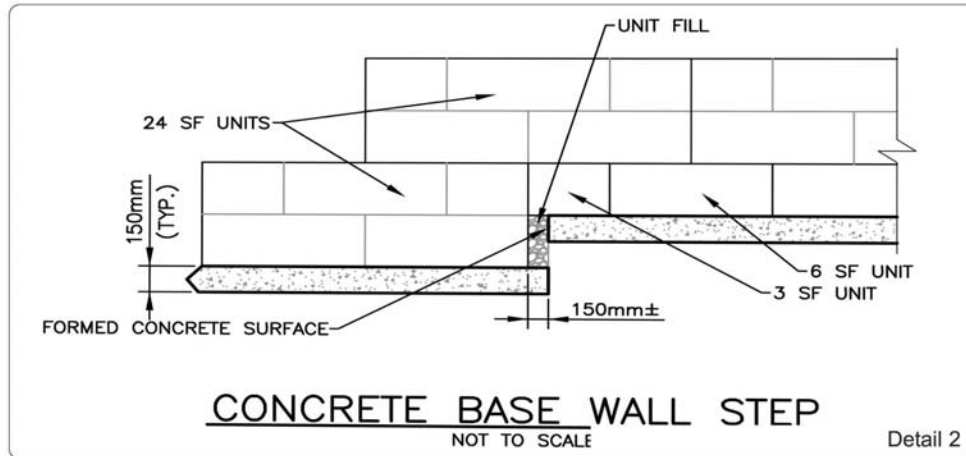

In some cases a mass extension unit or cast-in-place tail extension may be used to achieve taller walls in a gravity configuration. These units shall be installed in accordance with the plans or shop drawings. (see detail 3 and 3a)

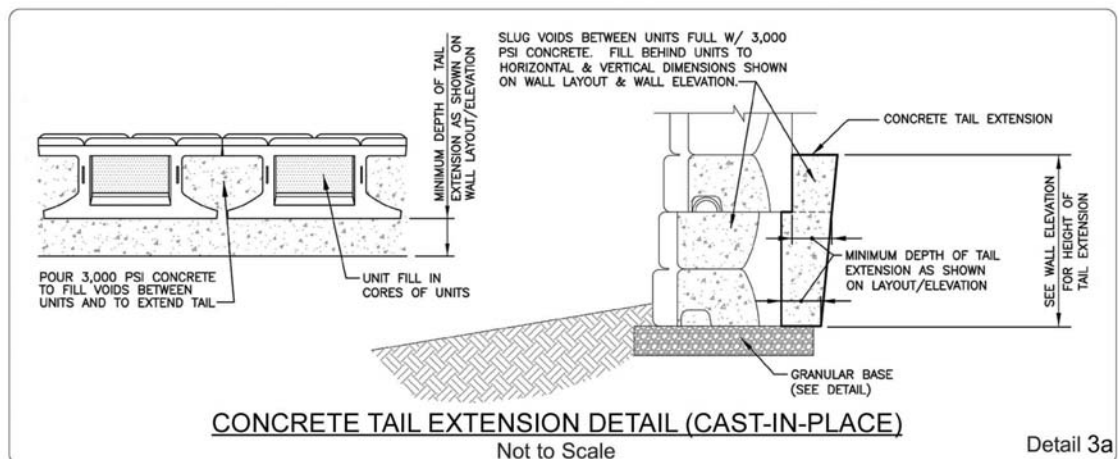
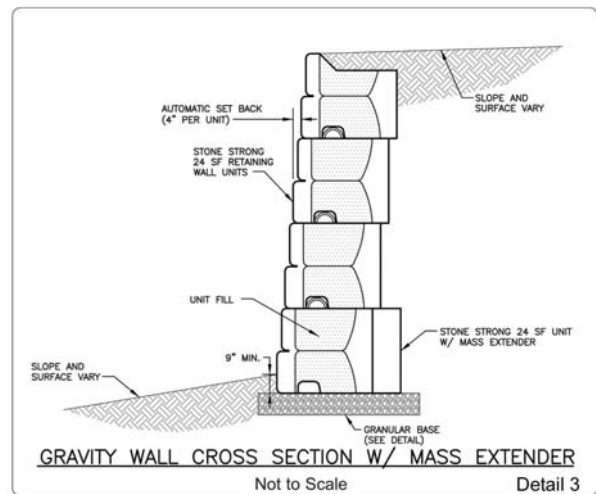



Fill all voids between and within the unit with granular unit fill. Unit fill shall consist of a screened crushed aggregate. A minimum of 75% of coarse material shall have 2 or more fractured faces. Wall base material shall meet the following gradation:

US Standard Sieve Size	Percent Passing
1-1/2"	100
3/4"	50-75
#4	0-40
#200	0-5

If shown on the plans or the shop drawings, provide a geotextile filter for separation from back-fill at the tails of the unit. The geotextile shall be a needle punched non-woven fabric with a minimum grab tensile strength of 120 pounds according to ASTM D 4632. If used, the geotextile may cover the entire back face of the unit or may be cut in strips to cover the gaps between tail unit with a minimum of 6 inches of overlap over the concrete tail on both sides (see detail 4).

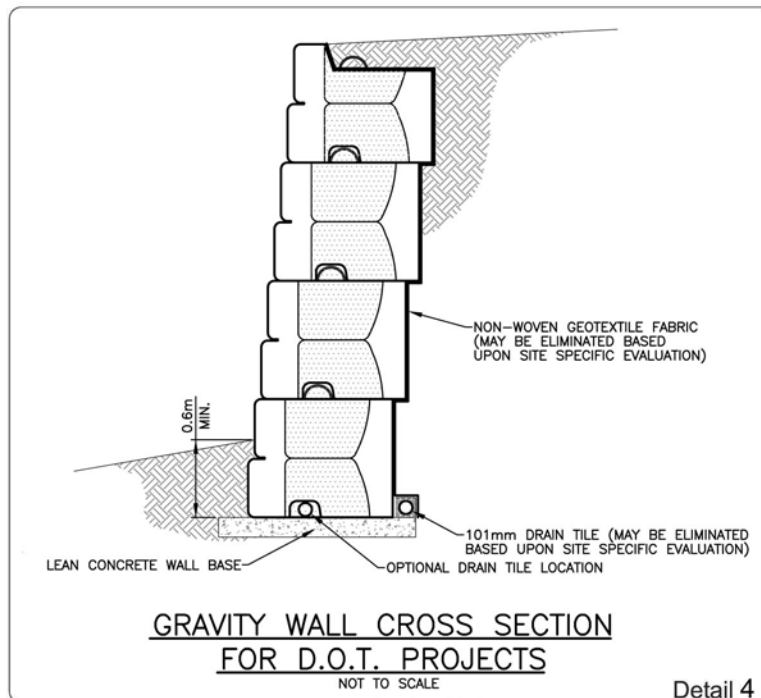

Drain tile shall be used if shown on the plans or if indicated by local practices and conditions. If used, the drain tile should be perforated or slotted PVC or corrugated HDPE pipe. The drain tile should be connected to storm drains or daylighted at low points and/or periodically along the wall alignment.

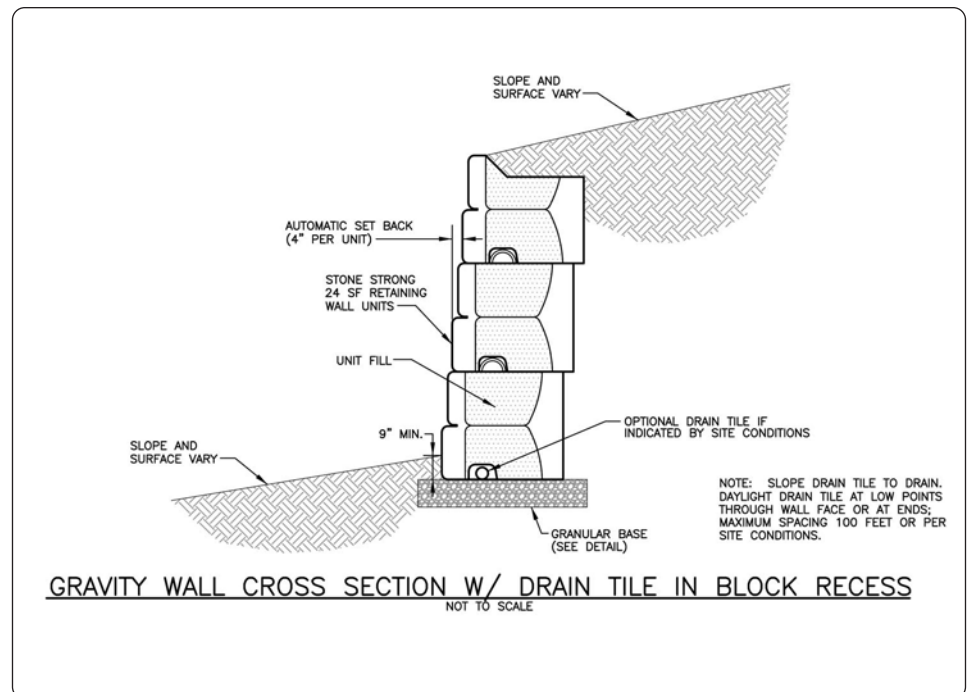
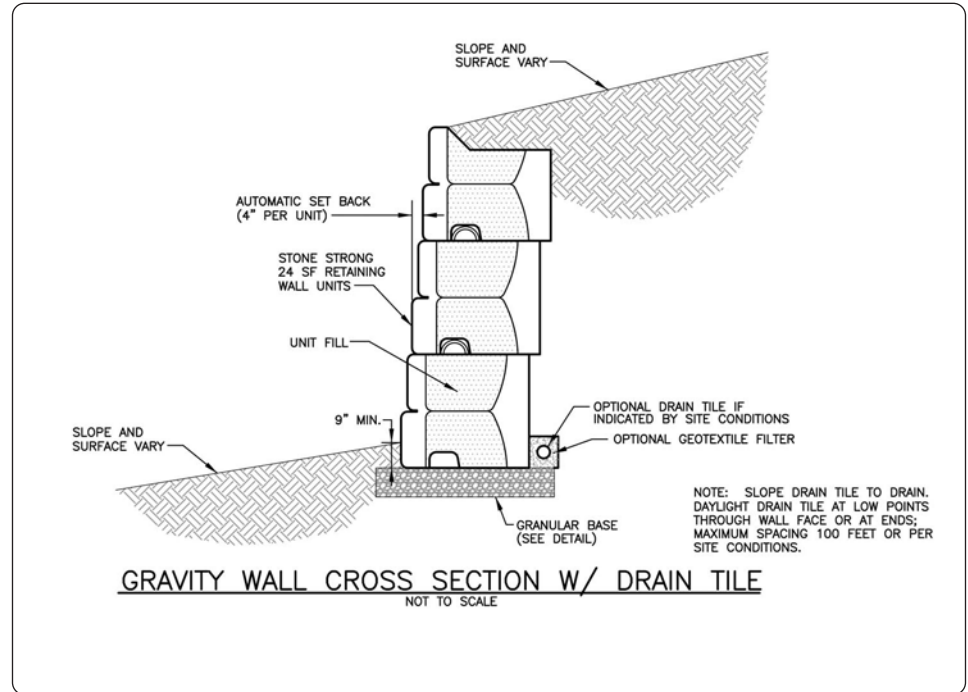

## Subsequent Courses

Remove all excess aggregate and other materials from the top of the unit before laying up the next course.

Place the next course of segmental unit in running bond with the previous course. Place the web notch over the alignment hoop protruding from the unit below, and pull the unit forward to contact the hoop. This alignment will produce a batter of 2 inches for every 18 inches of vertical wall height. Check the unit for level and alignment.



The layout of radius and corners shall be installed in accordance with the plans or shop drawings. See radius tables, included at the end of this manual.

Continue placing successive courses to the elevations shown on the plans. Construct wall in level stages, placing the unit at each course for the entire length of the wall, if possible. Unit fill and backfill should be placed to the level of the top of the facing unit before placing the next course. To step the top of the wall see detail 5 and 5a.

Provide temporary swales to divert runoff away from wall excavation and away from face during the construction phase.

Install the Stone Strong top unit. Place unit fill and backfill level with the back face of the unit.

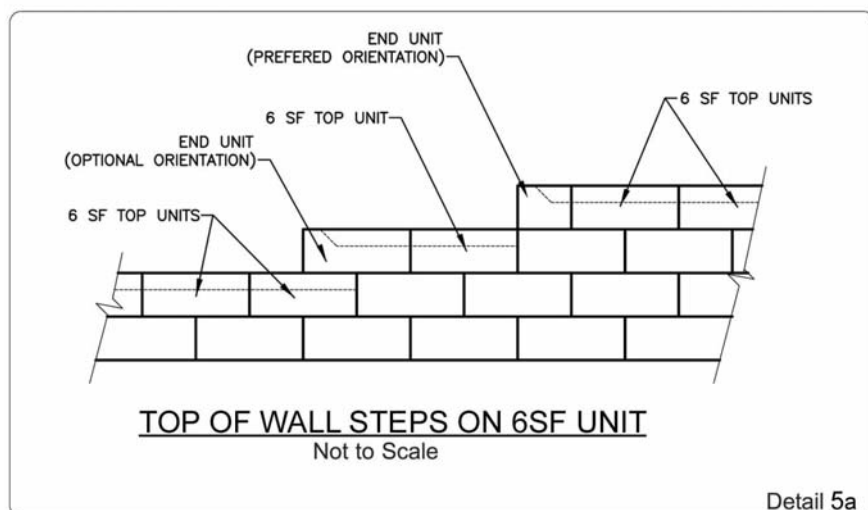
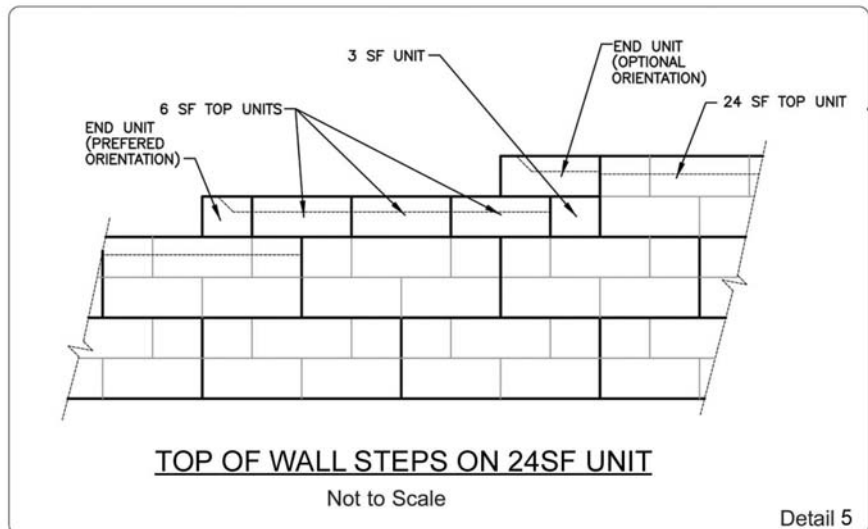

## BACKFILL PLACEMENT AND COMPACTION

Place backfill behind the unit in maximum loose lifts of 8 inches and compact. Backfill and compact behind the first course before installing other courses. If select granular fill is required, it shall consist of fill sand or other clean aggregate meeting the following gradation:

US Standard Sieve Size	Percent Passing
3/4"	100
#200	0-5

Compact all backfill to a minimum of 95 percent of the maximum dry density (ASTM D 698, Standard Proctor). For cohesive soils, the moisture content at the time of compaction should be adjusted to within -3 and +4 percent of optimum. Place backfill in successive lifts until level with the top of the facing unit. Additional unit fill is not required behind the unit, but may be placed for the convenience of the contractor.

All other backfill behind and in front of the wall shall consist of suitable on-site soil or imported borrow approved by the Geotechnical Engineer. Backfill shall generally consist of sands, silts, or lean clays with a liquid limit less than 45 and a plasticity index less than 20. Fat clay soils, cobbles, and large rock should generally be avoided unless approved by the Geotechnical Engineer based on local practices. Frozen soils, excessively wet or dry soils, debris, and deleterious materials should not be used.



Final grade above and below the retaining wall shall provide for positive drainage and prevent ponding. Protect completed wall from other construction. Do not operate large equipment or store materials above the wall that exceed the design surcharge loads.

## CLEANUP

Remove any damaged or unused Stone Strong unit.

Remove any unit fill or backfill material.

Remove debris caused by wall construction.

## TROUBLESHOOTING:

First course not level.	Wall base not level. Unit does not meet manufacturing specifications.
Wall leaning in.	Alignment loops not engaged. Unit not level.
Wall leaning out.	Alignment loops not engaged. Unit not level.
Wall has a dip.	Wall base not level. Wall base not properly compacted.
Unit will not stack flat.	Wall base not level. Unit does not meet manufacturing specifications. Excess aggregate or other material on top of unit.



**Top of Wall Treatments:**  
 Wall Capping

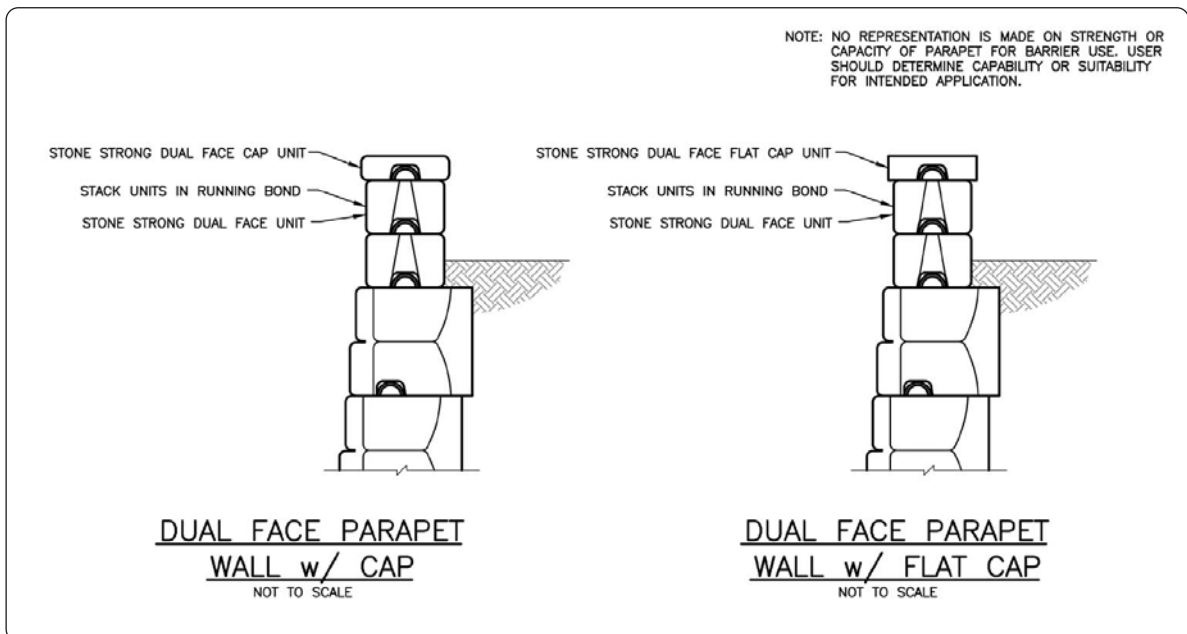
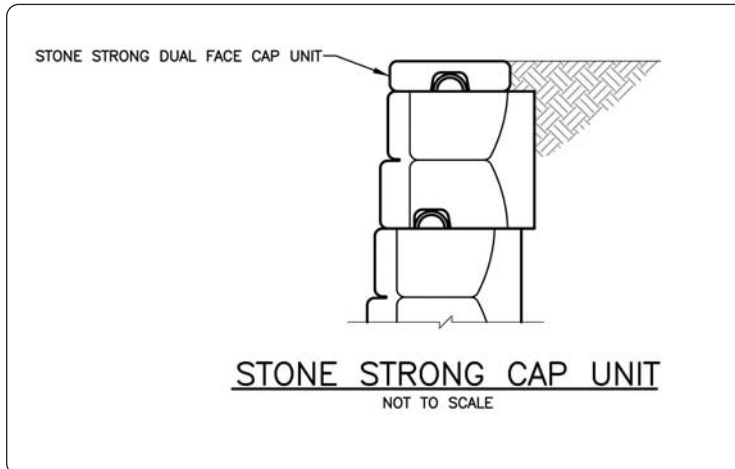

**Top of Wall Treatments:**  
 Fencing

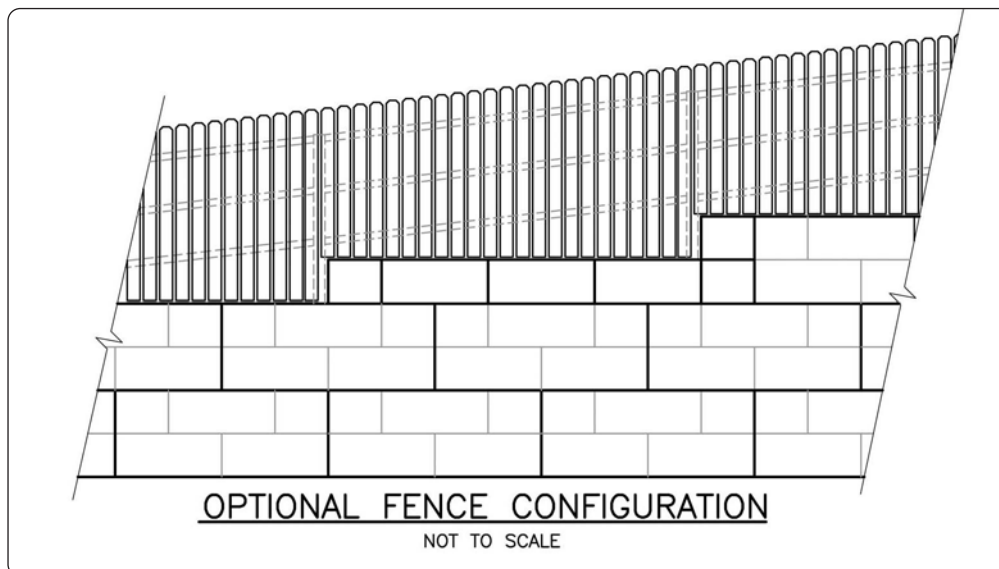
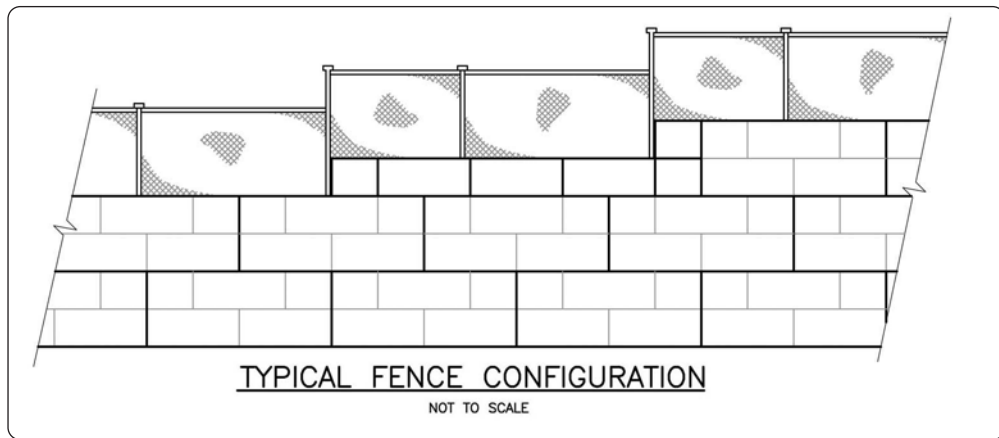
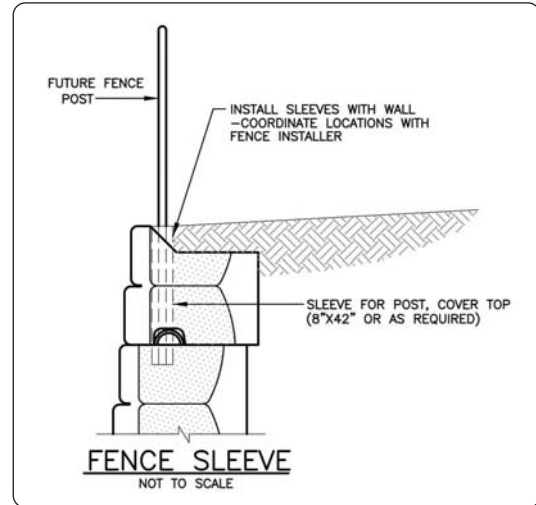

## Top of Wall Treatments: Guide Rails

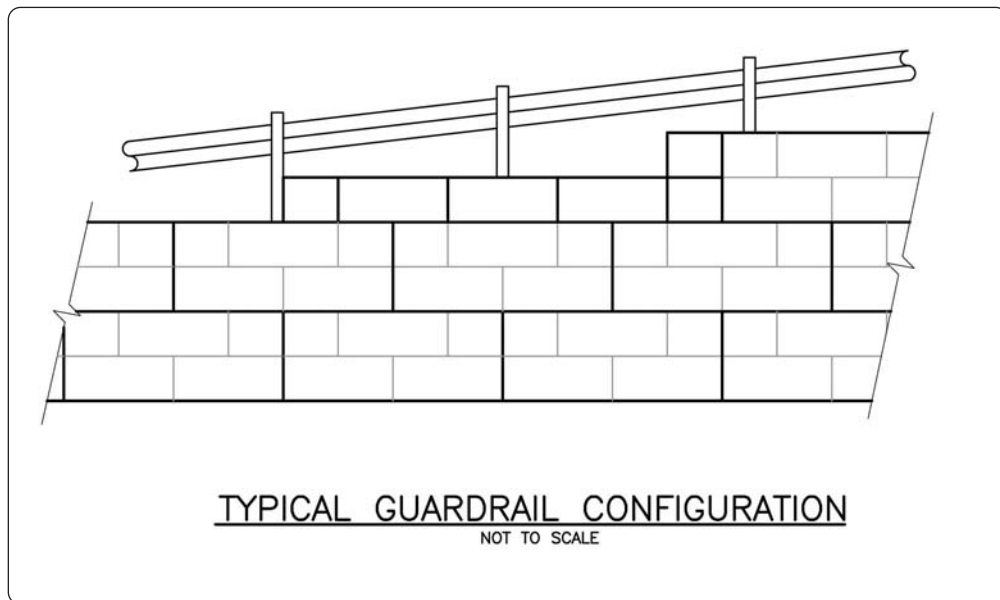
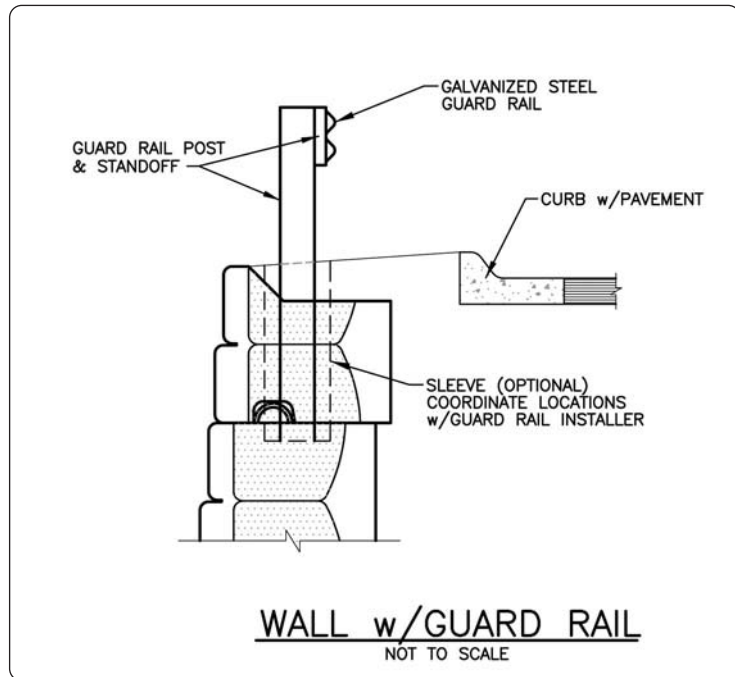



## Minimum Radius

R46" MIN.  
(SEE NOTE)

Minimum Concave Radius		
Wall Height (ft)	Total # of Courses	Reqd. Radius at Top Course
6	2	46' 4"
9	3	46' 8"
12	4	47' 0"
15	5	47' 4"
18	6	47' 8"
21	7	48' 0"
24	8	48' 4"

NOTE: MINIMUM RADIUS OCCURS AT LOWEST COURSE. RADIUS INCREASES 4" PER COURSE ABOVE, AS SHOWN ON TABLE.

**MINIMUM CONCAVE RADIUS-24 SF UNITS**  
 NOT TO SCALE

R=51'-8" MIN. (SEE NOTE)

Minimum Convex Radius		
Wall Height (ft)	Total # of Courses	Reqd. Radius at First Course
6	2	52' 0"
9	3	52' 4"
12	4	52' 8"
15	5	53' 0"
18	6	53' 4"
21	7	53' 8"
24	8	54' 0"

NOTE: MINIMUM RADIUS OCCURS AT TOP COURSE. REQUIRED RADIUS INCREASES 4" PER COURSE BELOW, AS SHOWN ON TABLE.

**MINIMUM CONVEX RADIUS-24 SF UNITS**  
 NOT TO SCALE

13'-6" MIN.  
(SEE NOTE)

NOTE: MINIMUM RADIUS OCCURS AT LOWEST COURSE. RADIUS INCREASES 2" PER COURSE ABOVE, AS SHOWN ON TABLE.

Minimum Concave Radius		
Wall Height (ft)	Total # of Courses	Reqd. Radius at Top Course
3	2	13' 8"
4 1/2	3	13' 10"
6	4	14' 0"
7 1/2	5	14' 2"
9	6	14' 4"
10 1/2	7	14' 6"
12	8	14' 8"

**MINIMUM CONCAVE RADIUS-6 SF UNITS**  
 NOT TO SCALE

16" MIN.  
(SEE NOTE)

NOTE: MINIMUM RADIUS OCCURS AT TOP COURSE. REQUIRED RADIUS INCREASES 2" PER COURSE BELOW, AS SHOWN ON TABLE.

Minimum Convex Radius		
Wall Height (ft)	Total # of Courses	Reqd. Radius at First Course
3	2	16' 2"
4 1/2	3	16' 4"
6	4	16' 6"
7 1/2	5	16' 8"
9	6	16' 10"
10 1/2	7	17' 0"
12	8	17' 2"

**MINIMUM CONVEX RADIUS-6 SF UNITS**  
 NOT TO SCALE



## Glossary

**Backfill** - Earth or other material placed between a retaining wall and existing ground.

**Base Course** - The first course to be installed. It may be totally or partially buried.

**Base Material** - A base pad of lean concrete with 228-day compressive strength of 3,000 psi or a free draining granular material compacted and leveled to receive the base course.

**Contractor** – The organization or individual that contracts with another organization or individual (the owner) for the construction of the retaining wall.

**Engineer** – The owners designated organization or individual with authoritative charge over engineering functions and responsibilities.

**Foundation Soil** - Soil zone immediately beneath the retaining wall unit, the wall leveling pad and the reinforced soil zone. It is important that it is sufficiently strong and that it will not consolidate. Any fill in the foundation soil must be compacted as structural fill.

**Granular unit fill** - Is defined as a free draining aggregate material which is small enough (3/4" to 1-1/2" minus material) to easily fill unit cores and the gaps between unit while containing minimal fine material (sands and silts) that could pipe through wall joints from occasional water flow.

**Owner** – The owner of the project for whom a contract has been made for the payment for the work performed under the terms of the contract.

**Wall base** - A gravel or concrete pad installed to create a level horizontal surface for wall construction.

**Shop Drawings** - is a drawing or set of drawings produced by the supplier to show details of installations for the contractor

**Soil compaction** - Proper placement and compaction of soils is essential to the successful performance of retaining wall structures. Soils must be compacted in lifts to achieve maximum soil shear strength and validate the design.

**Stone Strong Dealer** – Stone Strong representative available to provide technical assistance to the contractor, engineer or owner. Stone Strong dealer will supply the stone strong units for the construction of the wall. The dealer may also be requested to provide shop drawings for the installation of the wall.

